



# LZR<sup>®</sup> - FLATSCAN I

COMPACT LASER SCANNER FOR INDUSTRIAL DOORS.

User's Guide for software version SW 0100 and higher  
(refer to tracking label on product)

## INTRODUCTION



The FLATSCAN I is a laser sensor designed for the detection of objects around an industrial door. It generates an invisible curtain with 400 laser beams, which covers the detection area with a high resolution. It can be used for safe guarding level D according to the EN12453.

## DESCRIPTION

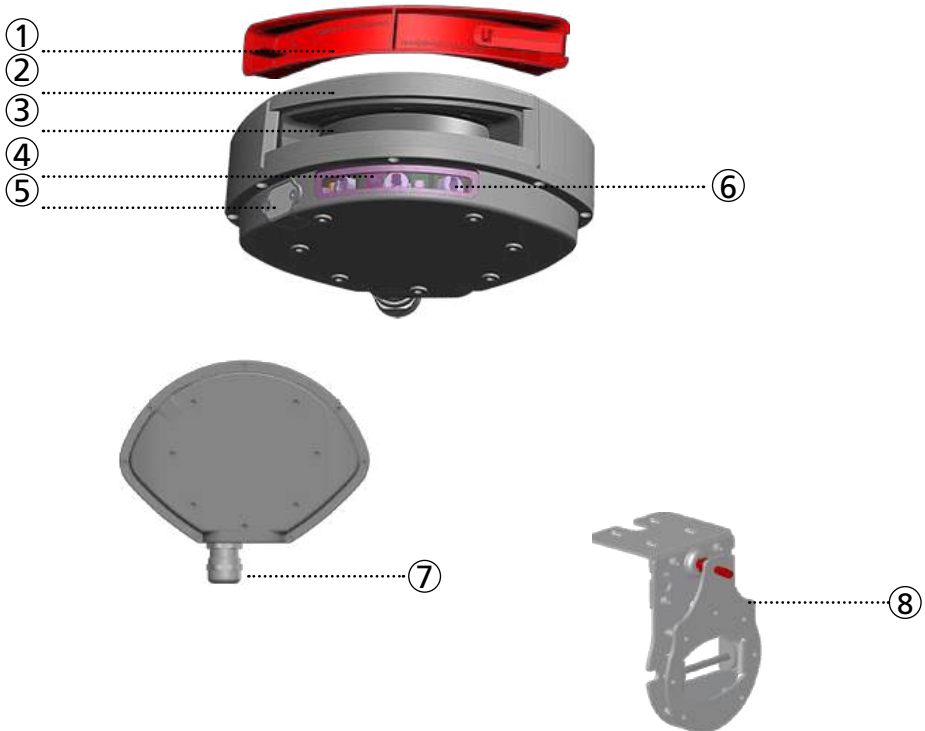

- |                                   |   |
|-----------------------------------|---|
| 1. Front cover (protective cover) | 5. USB connector (only for factory use) |
| 2. Housing                        | 6. Visible laser beams                  |
| 3. Laser window                   | 7. Cable gland                          |
| 4. LED-signal                     | 8. Bracket (optional)                   |

## LED-SIGNALS



detection



error LED



LED flashes quickly



LED flashes slowly



power on

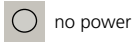

no power

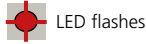

LED flashes



LED is off

## SYMBOLS



Caution!  
Laser radiation



Remote control  
sequence



Possible  
remote control  
adjustments



Factory values



Attention



Note

## SAFETY TIPS



The device emits invisible (IR) and visible laser radiations. The visible laser beams can be activated during the installation process to adjust the position of the detection field. Do not stare directly into the visible red beams. The visible laser beams are inactive during normal functioning.



### CAUTION!

Use of controls, adjustments or performance of procedures other than those specified herein may result in hazardous radiation exposure.



Do not stare into the visible red laser beams.



The warranty is invalid if unauthorized repairs are made or attempted by unauthorized personnel.



Only trained and qualified personnel may install and setup the scanner.

## INSTALLATION AND MAINTENANCE



Avoid extreme vibrations.



Do not cover the laser window.

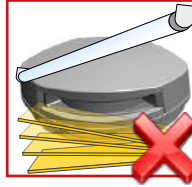

Avoid moving objects and light sources in the detection field.



Avoid the presence of smoke and fog in the detection field.



Avoid condensation.

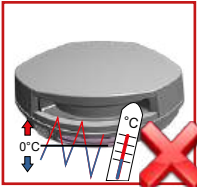

Avoid exposure to sudden and extreme temperature changes.



Avoid direct exposure to high pressure cleaning.



Do not use dry or dirty towels or aggressive products to clean the laser window.



Clean the laser window with compressed air. When needed, wipe the laser window only with a soft, clean and damp microfibre cloth.

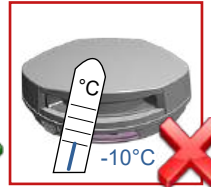

Keep the scanner permanently powered in environments where the temperature can descend below -10°C.

## INSTALLATION



- The sensor cannot be used for purposes other than its intended use.
- The manufacturer of the system incorporating the sensor is responsible for compliance of the system to applicable national and international regulations and safety standards.
- The installer must read, understand and follow the instructions given in this manual. Improper installation can result in improper sensor operation.
- The manufacturer of the sensor cannot be held responsible for injury or damage resulting from incorrect use, installation or inappropriate adjustment of the sensor.

## 1 MOUNTING



Only remove the front cover right before putting the sensor into service. Make sure the laser window is never covered.



Mount the sensor securely.

## Bracket installation (optional):



Prepare the bracket for the installation.



Fix the Flatscan I to the bracket

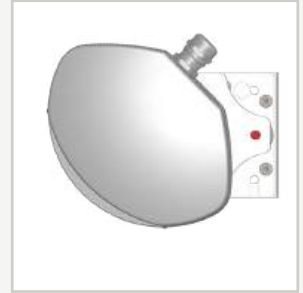

Choose an appropriate location and install the sensor on a solid surface.

## 2 WIRING

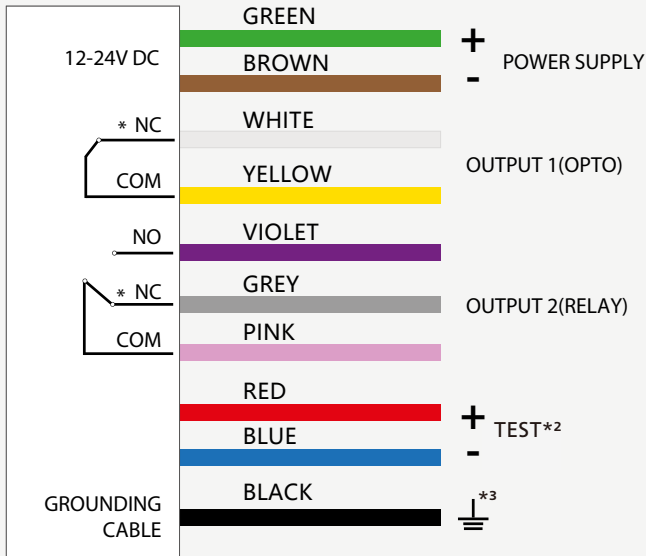

\* Output status when scanner is operational (Factory default connection)

\*<sup>2</sup> If the output test is not performed, the sensor must be checked periodically (at least every 6 months) to meet the Type D requirements of EN12453.

\*<sup>3</sup> Grounding: make sure that the sensor is correctly earthed.



When the monitoring, the red and blue cables must be connected to the power supply

## HOW TO USE THE REMOTE CONTROL

Before using the remote control, please check the following points:

1. The max. distance between the sensor and the remote control is 4 m.
2. The sensor's curtain should not be perpendicular to a high reflective surface. A 3-degree angle is necessary between them to guarantee communication between the sensor and the remote control.
3. The authorized operator or installer can set a password to avoid unwanted modifications in the chosen settings



After unlocking, the red LED flashes and adjustments can be made by remote control.



If the red LED flashes quickly after unlocking, you need to enter an access code (1 to 4 digits).



To end an adjustment session, always lock the sensor.

### ADJUSTING ONE OR MORE PARAMETERS

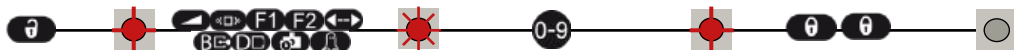

### CHECKING A VALUE



X = THE NUMBER OF FLASHES INDICATES THE VALUE OF THE PARAMETER.

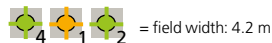

### RESTORING TO FACTORY VALUES



### SAVING AN ACCESS CODE

An access code is recommended for sensors installed close to each other.

The setting will take effect 1 minute later.



### DELETING AN ACCESS CODE



After power on, you have 1 minute to choose this setting.



30 minutes after last use, the sensor locks the access to the remote control session.

Cut and restore power supply : the remote control session will be accessible again during 30 minutes.

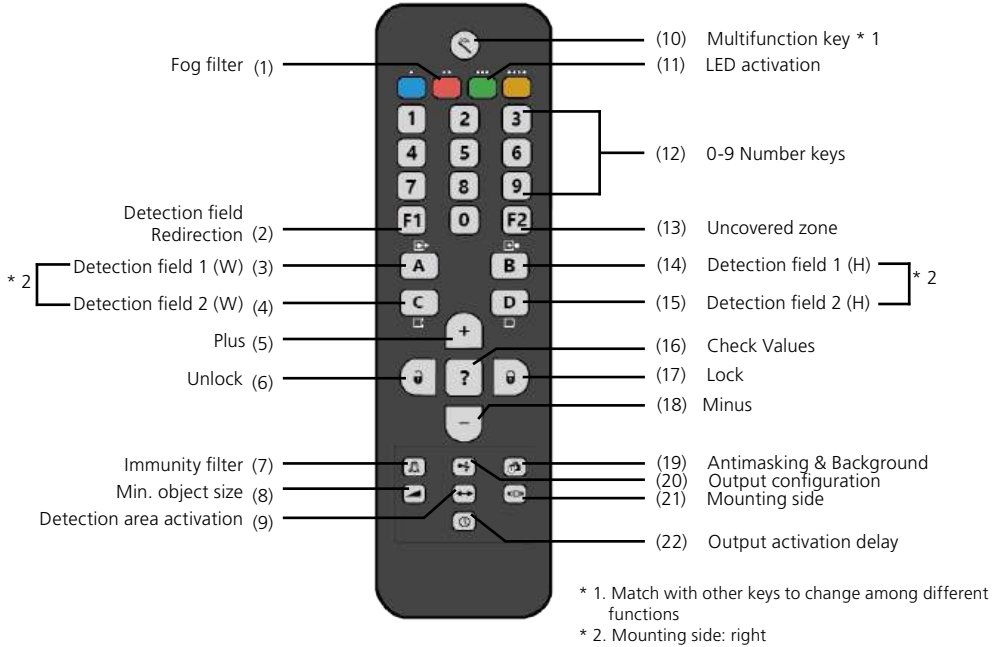

**VISIBLE SPOTS**

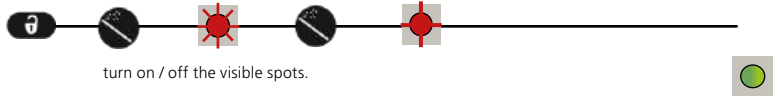

turn on / off the visible spots.

The visible spots will be automatically deactivated after 10 minutes.  
30 minutes after the installation, you will need to reboot the sensor to be able to re-activate the visible spots.

**ALIGNMENT**

- Check the sensor's wiring.
- Set power to on.
- Switch on the visible spots, then align the curtain position precisely (refer to remote control instruction). If necessary, adjust the tilt angle (with the universal bracket) to make sure the curtain covers the whole detection area
- The laser spots have an oval shape. The further the laser spot hits, the bigger the spot diffuses (see diagram below).

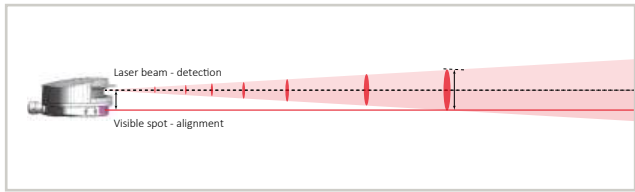

**!** Please make sure the detection curtain is in the right position for the intended application.

**TYPE D POSITIONING**

- Visible spots position less than 15cm
- Recommended mounting height 2.5m
- Output test must be applied or a periodical checkup at least every 6 months.

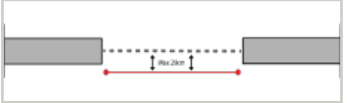

**MOUNTING  
SIDE**

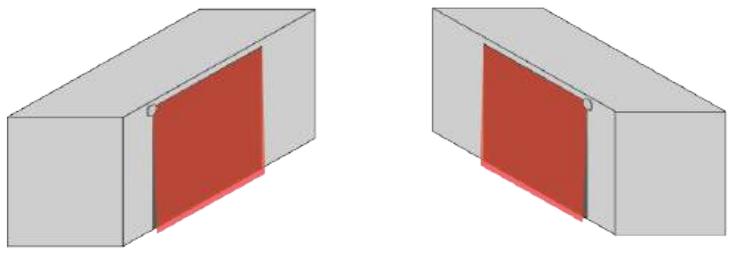

The Flatscan I can be placed either on the left side, right side or in a central position.

**DETECTION  
FIELD**



 Detection area: detection will only be triggered by objects located in the detection area. The dimension of detection area can be adjusted via the parameter.

Please note that the detection range can be guaranteed with a 5% reflectivity @4m diagonal when the fog filter value is set to 0.

If the fog filter value is not set to 0, then the guaranteed detection distance with 5% reflectivity will be shortened.

## UNCOVERED ZONE

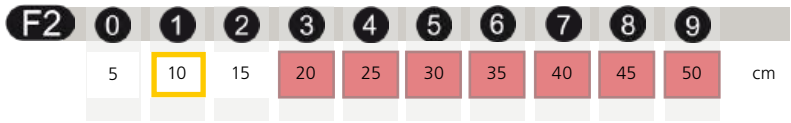

Uncovered zone: can be increased in case of snow, dead leaves, etc.  
Measured in specific conditions and determined by application and installation.

## IMMUNITY FILTER

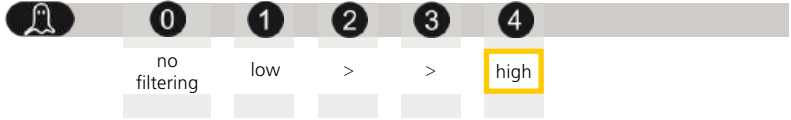

Immunity Filter: is increased to filter out environmental interferences such as rain or snow which can trigger false detection.

## FOG FILTER

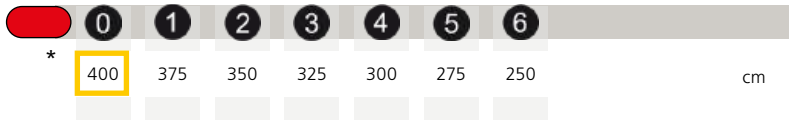

\*the sensor does not comply with Type D (EN 12453) requirements when used in detection areas exceeding the dimensions of the fog filter.



Fog filter: you can change the max. detection distance with a 5% reflectivity.

## MIN. OBJECT SIZE

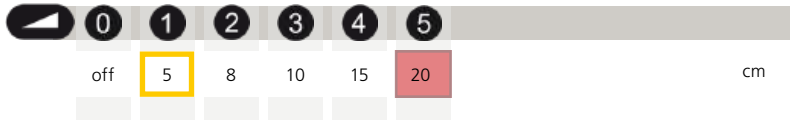

Minimum object size: detection will only happen when the detected object size is bigger than the given minimum object size.

## OUTPUT ACTIVATION DELAY



Output activation delay: the detection will generate an output only when the detection lasts longer than the chosen time.

### DETECTION AREA ACTIVATION

|  |     |         |         |                     |
|--|-----|---------|---------|---------------------|
|  | 0   | 1       | 2       | 9                   |
|  | OFF | field 1 | field 2 | field 1 and field 2 |

Detection area activation: detection field 1 or detection field 2 can be activated or deactivated according to the application.

### DETECTION FIELD REDIRECTION

|           |         |         |                    |                    |
|-----------|---------|---------|--------------------|--------------------|
| <b>F1</b> | 0       | 1       | 2                  | 3                  |
| R1        | field 1 | field 2 | field 1 or field 2 | error alarm        |
| R2        | field 2 | field 1 | error alarm        | field 1 or field 2 |

### OUTPUT CONFIGURATION

|      |    |    |    |    |  |
|------|----|----|----|----|--|
|      | 1  | 2  | 3  | 4  |  |
| R1   | NO | NC | NC | NO |  |
| * R2 | NC | NO | NC | NO |  |

NO

NC

NO POWER

NO DETECTION

DETECTION

NO = normally open  
NC = normally closed

\* R2 default connection: Pink/ Grey

### ANTIMASKING

|             |     |    |
|-------------|-----|----|
|             | 0   | 2  |
| antimasking | OFF | ON |

Antimasking: when the laser window is covered, the sensor will enter the error mode.

### LED ACTIVATION

|  |         |        |
|--|---------|--------|
|  | 0       | 1      |
|  | LED OFF | LED ON |

## TEACH-IN

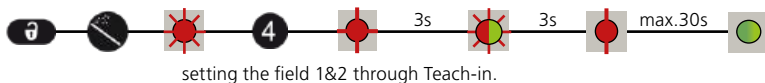

Teach-in: the sensor can automatically learn its environment and its detection field. It will adapt its detection field when the background changes.

## RESET TO FACTORY SETTINGS

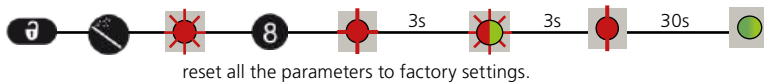

**⚠ IMPORTANT:** Test the good functioning of the installation before leaving the premises.

## TROUBLESHOOTING

|  |   |  |   |   |
|--|---|--|---|---|
|  | The ORANGE LED is on permanently.                     | The sensor encounters a memory problem.  |   | Send the sensor back for a technical check-up.                      |
|  | The ORANGE LED flashes 1 x /2 x /3 x every 3 seconds. | The sensor signals an internal fault.<br>If the internal error still appears after 3 resettings, the LED will flash 9 times and the sensor will be locked. | 1 | Cut and restore power supply.                                       |
|  |   |  | 2 | If orange LED flashes again, send the sensor back to manufacturer.  |
|  | The ORANGE LED flashes 4 x every 3 seconds.           | Masking or background error  | 1 | Remove any pollution on the front window                            |
|  |   |  | 2 | Check background and remove any object that could provoke the error |
|  | The ORANGE LED flashes 5 x every 3 seconds.           | Error during the teach-in process.   |   | Relaunch a teach-in process.  |

## TECHNICAL SPECIFICATIONS

|  |   |
|--|---|
| <b>Technology</b>                                  | LASER scanner, time-of-flight measurement   |
| <b>Detection mode</b>                              | Presence  |
| <b>Max. detection range</b>                        | Max. 5.5m*5.5m (4m@5% reflectivity)   |
| <b>Field of view</b>                               | 90°   |
| <b>Angular resolution</b>                          | 0.23° (400 spots within 90°)  |
| <b>Optical characteristics</b><br>(IEC/EN 60825-1) | Wavelength 905nm; output power < 0.1 mW ; CLASS 1<br>Wavelength 635nm; output power < 1 mW ; CLASS 2 - Visible spot   |
| <b>Supply voltage</b>                              | 12-24V DC ± 15%   |
| <b>Power consumption</b>                           | ≤ 2.3W, peak current: 1A  |
| <b>Response time</b>                               | Max. 50ms + output activation delay   |
| <b>Output*</b>                                     | 1 opto (galvanic isolation - polarity free)<br>Max. switching voltage: 30V AC/ 42V DC<br>Max. switching current: 100mA<br>1 Relay (free of potential contact)<br>Max. contact voltage: 30V AC/ 42V DC<br>Max. contact current: 1A (resistive)<br>Max. switching power: 30W DC/60VA AC |
| <b>LED-signals</b>                                 | 1 tri-colored LED: detection / output status  |
| <b>Dimensions</b>                                  | 124mm (L) × 90mm (H) × 50mm (D) (without bracket)   |
| <b>Colour</b>                                      | Black   |
| <b>Tilt angles</b>                                 | ±3° (with bracket)  |
| <b>Protection degree</b>                           | IP66 (IEC/EN 60529)   |
| <b>Temperature range</b>                           | -30°C to +60°C if powered   |
| <b>Humidity</b>                                    | 0-95% non-condensing  |
| <b>Vibrations</b>                                  | < 2G  |

Specifications are subject to change without prior notice. All values are measured in specific conditions.

\* External electrical sources must be within specified voltages and ensure double insulation from primary voltages.



BEA hereby declares that this product is in compliance with European legislation 2014/30/EU (EMC) and 2011/65/EU (RoHS). The complete declaration of conformity is available on our website.



This product should be disposed of separately from unsorted municipal waste.

